

COGNEX

BUILD YOUR VISION

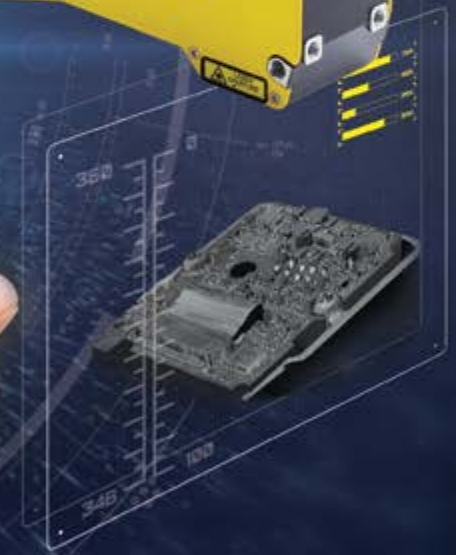
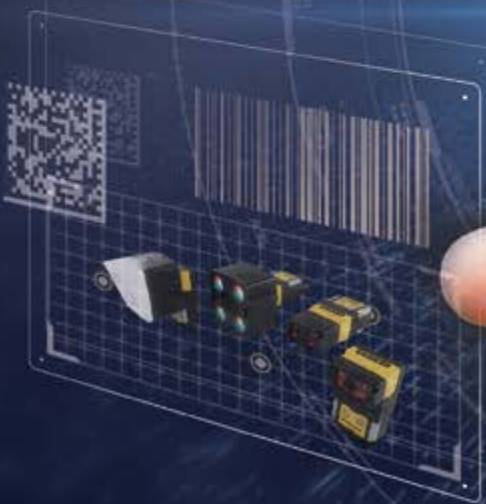

WE MAKE COMPUTERS THAT CAN SEE.

Cognex® is the largest and most recognized global supplier of industrial machine vision.

Cognex systems emulate human eyes and brains. Each system consists of optics, an image sensor, and high-speed electronics that work together to capture an image, then software analyzes that image and makes sense of what's being seen. While this process is second nature to humans, it is a very complex challenge for a computer.

Cognex is focused on solving the toughest problems in machine vision and industrial barcode reading, and we have sold more solutions in these areas than any other company in the world.



THE GLOBAL LEADER IN MACHINE VISION AND BARCODE READING

For over 40 years, Cognex has helped the world's most innovative companies make their manufacturing and distribution faster, smarter, and more efficient.

Cognex vision and barcode reading systems help improve product quality and track items through each stage of production and distribution. Using data from the billions of digital images captured by Cognex vision systems, companies can monitor, update, and change production plans in real-time across global supply chains. And Cognex is constantly applying new techniques like artificial intelligence and 3D sensing to help companies push production limits beyond what they previously thought possible.

\$1 BILLION
2022 REVENUE

4,000,000+
SYSTEMS SHIPPED

OVER 42
YEARS IN THE BUSINESS

GLOBAL OFFICES IN
20+ COUNTRIES

500+
CHANNEL PARTNERS



MACHINE VISION

Tens of thousands of applications worldwide inspect billions of products each day, many products that simply could not be manufactured without machine vision technology. Whether verifying the fill levels of soda bottles traveling on a conveyor, reading oil-stained DPM codes on automotive parts, or positioning touch screens on smartphones to micron-level accuracy, machine vision technology performs highly-detailed tasks on high-speed production lines.

Cognex machine vision products help companies:

- **Optimize quality**
- **Minimize waste**
- **Maximize throughput**



AI TECHNOLOGY

Cognex AI-based solutions learn to spot patterns and anomalies from example images to solve complicated tasks and provide consistency and speed that aren't possible with manual inspection.



Edge learning

Subset of AI in which processing takes place

on-device, or "at the edge," using a pre-trained set of algorithms. This technology is simple to setup, requiring smaller image sets and shorter training and validation periods than traditional deep learning.

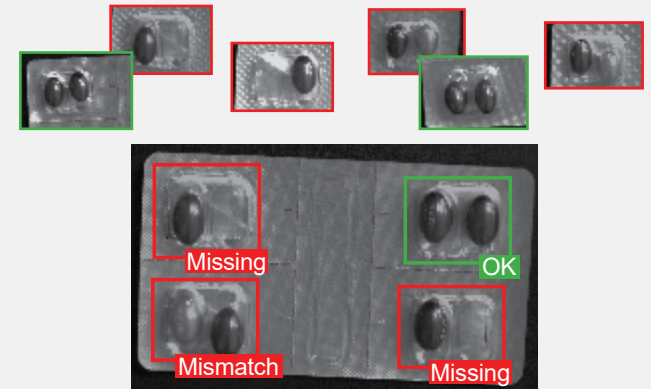

Deep learning

Designed to automate complex or highly

customized applications. This technology enables users to analyze vast image sets quickly and efficiently, while accurately differentiating between acceptable and unacceptable anomalies.

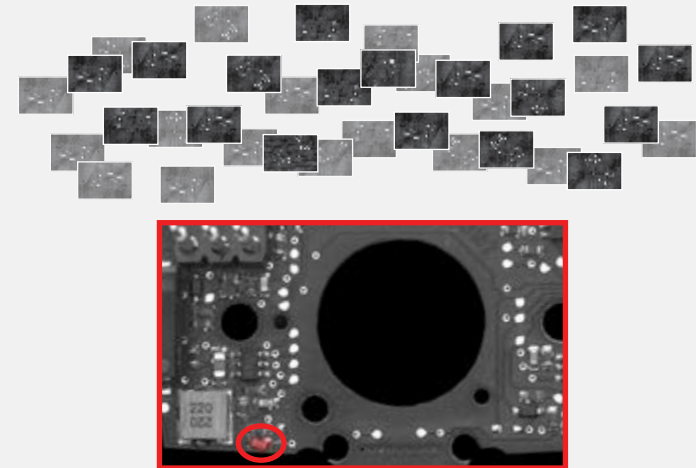

2D VISION SENSORS AND SYSTEMS

In-Sight 3800 Series

Designed for fast-paced applications, In-Sight 3800 delivers a fully integrated solution for manufacturing automation. Embedded with the latest vision technologies, this powerful system offers high speed, high flexibility, and high resolution, allowing users to maximize throughput, scale their solution, and run more accurate inspections.



TOOL SET



RESOLUTION



FEATURES

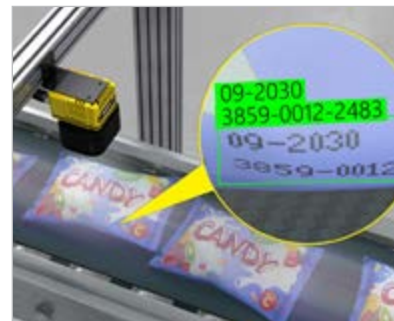
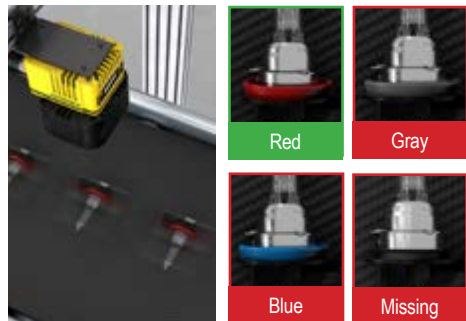

In-Sight 2800 Series

Combines edge learning technology with traditional rule-based vision tools to solve a range of error-proofing tasks. From presence/absence detection to sortation and character reading, this fully integrated vision system offers an easy-to-use solution for automating inspections.



TOOL SET



RESOLUTION



FEATURES

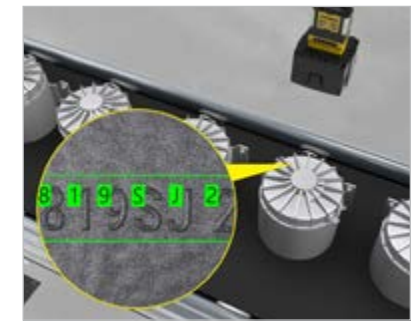

In-Sight D900 Series

The In-Sight D900 vision system leverages advanced AI-based tools to solve challenging OCR, assembly verification, and defect detection tasks. Processing takes place on-device, which eliminates the need for a PC, simplifying application deployment.



TOOL SET



RESOLUTION

Up to 5MP

FEATURES

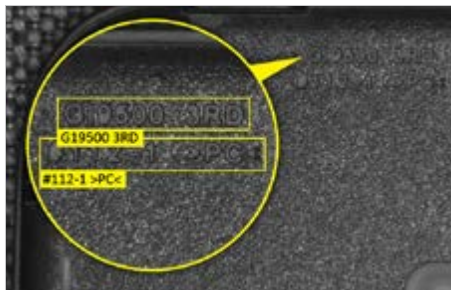
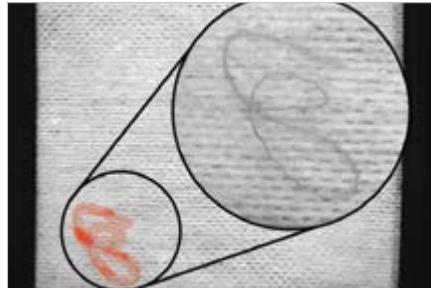

In-Sight 9000 Series

Rugged, ultra-high-resolution standalone vision system equipped with a full suite of vision tools solves high-accuracy part location, measurement, and inspection applications. Line scan and area scan image acquisition options are available for imaging large, continuously moving or stationary objects.



TOOL SET



RESOLUTION

Area Scan: Up to 12MP
Line Scan: Up to 32MP

FEATURES

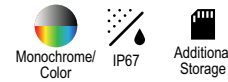

In-Sight 8000 Series

Ultra-compact standalone vision system delivers industry-leading vision performance in the micro form factor of a typical GigE vision camera.



TOOL SET



RESOLUTION



Up to 5MP

AVAILABLE FEATURES



Monochrome/
Color



Micro



PoE



HDR+

In-Sight 7000 Series

Combines modular integrated lighting with powerful vision tools in a compact footprint to deliver fast, accurate inspections on space-constrained production lines.



TOOL SET



RESOLUTION



Up to 5MP

FEATURES



Monochrome/
Color



IP67



HDR+



Autofocus



Autofocus

In-Sight 2000 Series

Ideal for solving simple pass/fail inspections, these vision sensors offer high value, ease of use, and the flexibility to adapt to virtually any production line environment.



TOOL SET



RESOLUTION



3.75 μm^2 pixel size

FEATURES



Monochrome/
Color



Autofocus



Autofocus



IP65

IN-SIGHT VISION SOFTWARE



All In-Sight products are configured with In-Sight Vision Suite software, which offers two development options — EasyBuilder® and spreadsheet. With point-and-click training, the intuitive EasyBuilder interface is ideal for setting up simple or common jobs, while the robust spreadsheet environment provides additional power and flexibility for advanced or customized applications.

In-Sight Vision Suite also offers the widest range of built-in communication protocols that interface directly to any PLC, robot, or HMI on the factory network.

3D VISION SYSTEMS

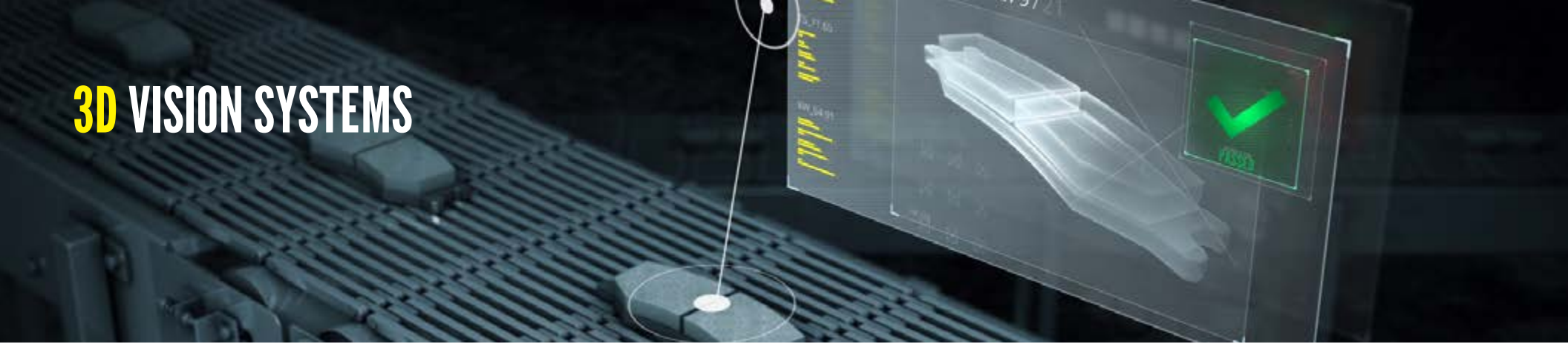

Whether performing a single profile measurement or scanning an entire surface, Cognex has the most powerful and robust 3D vision tools. Manufacturers in all industries trust Cognex technology to deliver high accuracy surface measurements that go beyond the capabilities of 2D vision technology.

In-Sight 3D-L4000 Series

A unique vision system combining 3D laser displacement technology with a high-performance smart camera. It allows factory engineers to quickly, accurately, and cost effectively solve a wide variety of inspections thanks to a comprehensive suite of true 3D vision tools, easy setup, and speckle-free blue laser optics.

TOOL SET



3D RESOLUTION

 **2000 points**

FEATURES



 ESD-Safe

 Factory Calibrated

 IP65

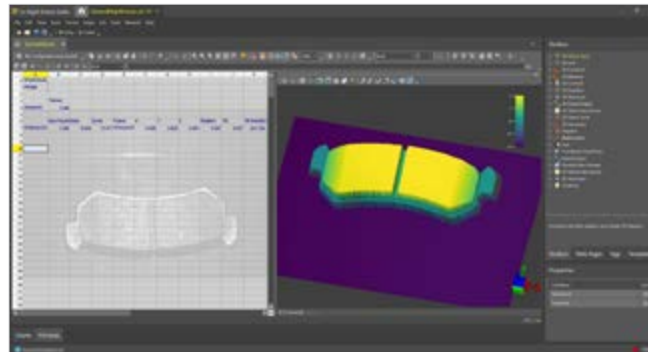
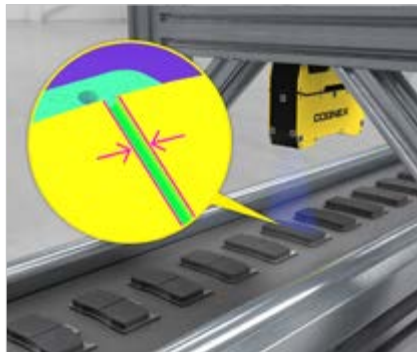

3D-A5000 Series

State-of-the-art area scan camera captures high-resolution 3D point cloud images in less time than alternative methods. Using unique 3D imaging technology, it solves challenging assembly verification, in-line metrology, and robotic guidance applications.

TOOL SET



3D RESOLUTION

 **1.5 million points**

FEATURES



LightBurst



Factory Calibrated



IP65

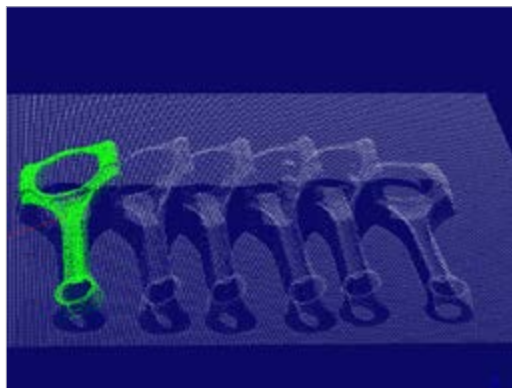

3D-L4000 with VisionPro

Powerful laser displacement sensor with PC-based development environment performs fast, accurate 3D inspections, measurements, and OCR character reading. Equipped with industry-leading 3D vision tools and delivers results in real-world units.

TOOL SET



3D RESOLUTION

 **960-1920 points**

FEATURES



Factory Calibrated



ESD-Safe



IP65

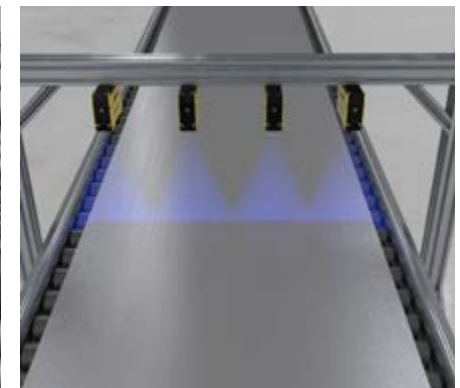
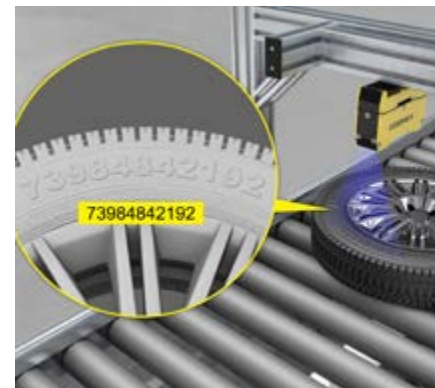

VISION SOFTWARE

VisionPro

VisionPro® 10 is a PC-based software that combines best-in-class vision technologies in a graphical programming environment. Powerful enough to solve the most challenging vision tasks, it enables rapid deployment of highly-customizable applications, from geometric object location and inspection to identification, measurement, and alignment. With a future-oriented design that includes rule-based tools and AI capabilities, this flexible software supports both current and future vision needs.

TOOL SET

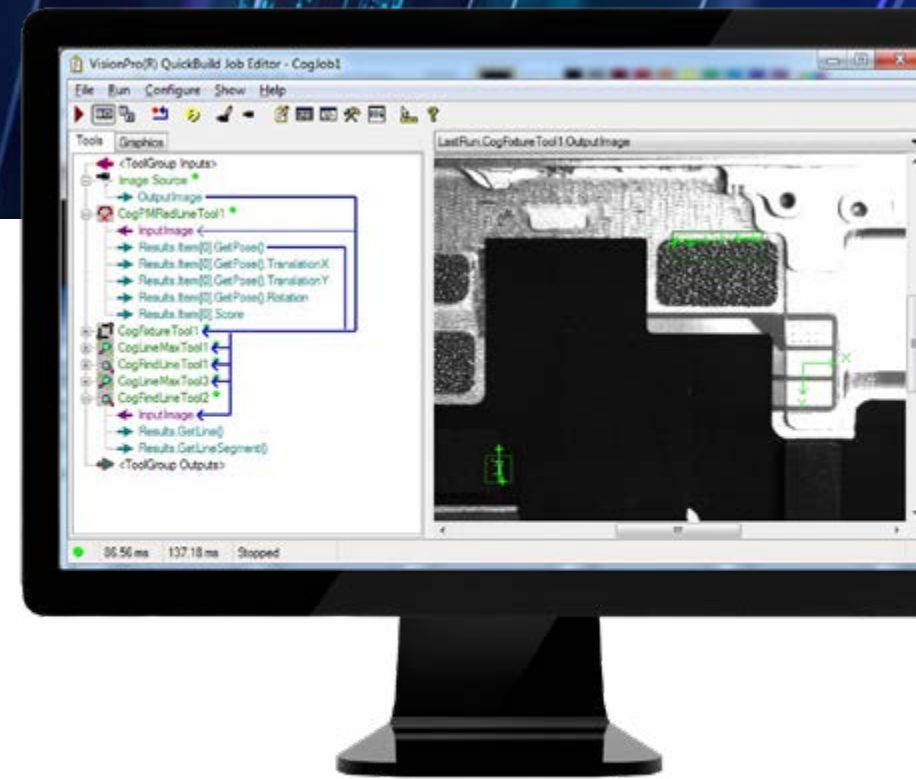

Extensive library of AI- and rule-based tools tackle your toughest vision challenges

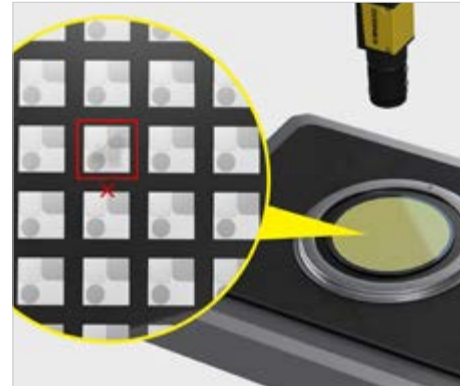

BARCODE READING

Nearly every product uses a 1D or 2D barcode to automate and simplify identification and data capture. The basic process in reading codes is to 1) illuminate the code, 2) locate the code, and 3) extract the data. Organizations must be able to read codes quickly and accurately for maximum efficiency and throughput.

Cognex image-based barcode readers decode 1D and 2D codes, from printed labels to the hardest to read direct part mark (DPM) codes, and deliver industry-leading read rates. Advanced technology, modular options, and easy setup help to reduce costs, optimize performance, increase throughput, and control traceability.



FIXED-MOUNT BARCODE READERS

DataMan 470 Series

Premium reader with multi-core processing power and advanced imaging technology for complex, high-throughput 1D and 2D code applications.



| POWER | RESOLUTION | CONNECTIVITY | SYMBOLOLOGIES |
|-------------|------------|------------------------|---------------|
| 7.5X | 5MP | Serial GigaBit | 1D 2D |
| FEATURES | | | |
| Hotbars | PowerGrid | High Speed Liquid Lens | |
| Laser Aimer | SD | Modular | EI |
| | | | HDR HDR+ |

DataMan 370 Series

Delivers superior read performance for the broadest range of applications, including multi-code, multi-symbology applications.



| POWER | RESOLUTION | CONNECTIVITY | SYMBOLOLOGIES |
|-------------|------------|------------------------|---------------|
| 5X | 5MP | Serial GigaBit | 1D 2D |
| FEATURES | | | |
| Hotbars | PowerGrid | High Speed Liquid Lens | |
| Laser Aimer | SD | Modular | EI |
| | | | HDR |

DataMan 280 Series

Premium decoding technology in a compact form factor.

POWER



RESOLUTION



CONNECTIVITY



SYMBOLOLOGIES



FEATURES



DataMan 70 Series

Compact design ideal for reading 1D and 2D label-based codes in tight application spaces.

POWER



RESOLUTION



CONNECTIVITY



SYMBOLOLOGIES



FEATURES



DataMan 580 Fixed-Mount Barcode Reader for Tunnel Applications

Enables greater throughput while maintaining high read-rates and short gaps between packages on high-speed lines utilizing a 9 MP imager and Cognex's 1D/2D QuickSort™ algorithm.



HANDHELD BARCODE READERS



DataMan 8700DX

Offers cutting-edge performance and operator feedback on the most challenging DPM and label-based codes while withstanding harsh oils, dirt, and water.

RESOLUTION



CONNECTIVITY



SYBLOGIES



FEATURES



DataMan 8700DQ

Decodes well-marked DPM codes.



DataMan 8700LX

Decodes well-marked 1D and 2D label-based codes.



DataMan 8700HD

Decodes well-marked 1D and 2D label-based codes as small as 2 mil in size.

RESOLUTION



CONNECTIVITY



SYBLOGIES



FEATURES



Cognex Mobile Barcode Software Development Kit (SDK)

The Cognex Mobile Barcode SDK is an easy-to-use software for creating and deploying mobile barcode reading applications. The SDK offers a unified solution, allowing users to maintain all mobile devices across their entire organization from a single platform. It can be used with any smartphone or tablet with a built-in camera, and even embedded systems.



BARCODE VERIFIERS

Barcode verification is the process of grading the quality of barcodes to globally accepted standards. Cognex barcode verification technology ensures the readability and compliance of codes and provides detailed summary reports.



DataMan 475V Series Inline Verifier

Grades 1D, 2D, and DPM codes from a fixed position on the production line.

FIELD OF VIEW

80 x 60 mm,
35 x 29 mm

SYBLOGIES



LIGHTING



DataMan 475VS Series Offline Verifier

Grades 1D, 2D, and DPM codes on a wide range of parts with an easy-to-use, adjustable height stand.

FIELD OF VIEW

80 x 60 mm,
35 x 29 mm

SYBLOGIES



LIGHTING



DataMan 8072V Series Handheld Verifier

Grades the most difficult DPM codes with 30/45/90-degree angle lighting options.

FIELD OF VIEW

27 x 20 mm,
17 x 13 mm

SYBLOGIES



LIGHTING



COGNEX EDGE INTELLIGENCE



The Cognex Edge Intelligence (EI) platform provides visibility into what is happening on your line, transforming big data into smart data for greater efficiency. EI is fully integrated with select Cognex products and logistics tunnels to streamline device management. Users can access visualization and diagnostics tools to identify and resolve issues quickly.



Connect via web browser

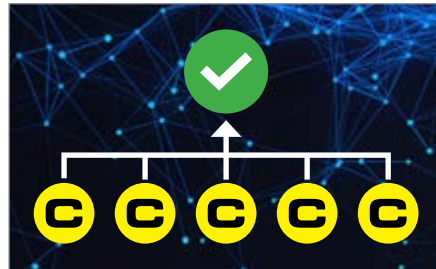

Automatically discover and subscribe to Cognex products

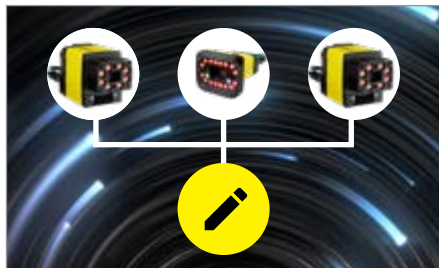

Configure multiple devices at once



Securely store and share data

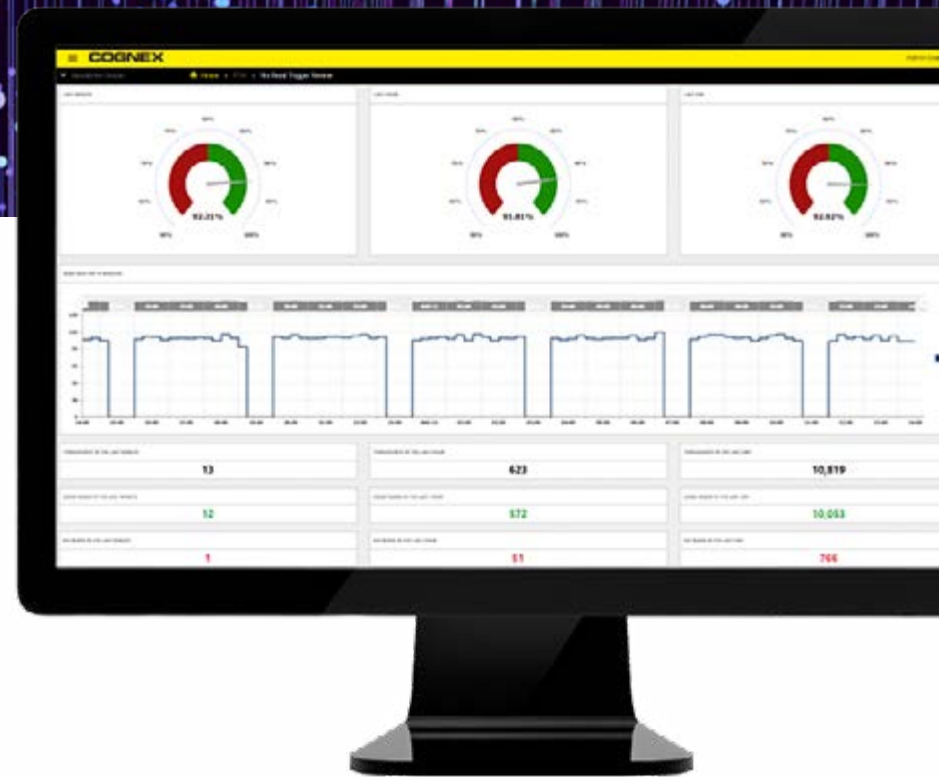

Performance dashboards, read rate trends, setup, commissioning, and calibration tools

THE MOST INDUSTRY EXPERIENCE

We serve hundreds of different markets. Here are some of the largest and fastest-growing industries for machine vision and industrial barcode reading.

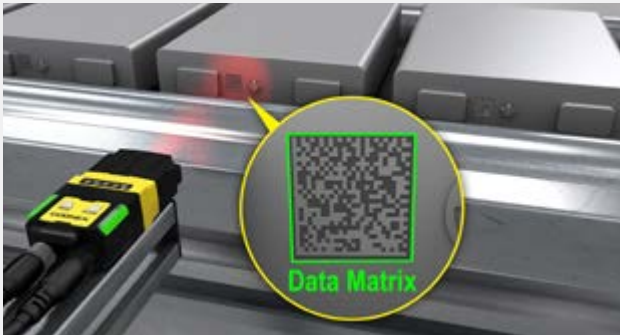

Automotive



Consumer electronics



Food & beverage

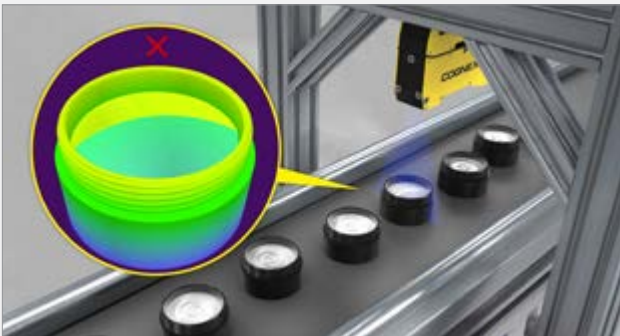

Consumer products



Logistics

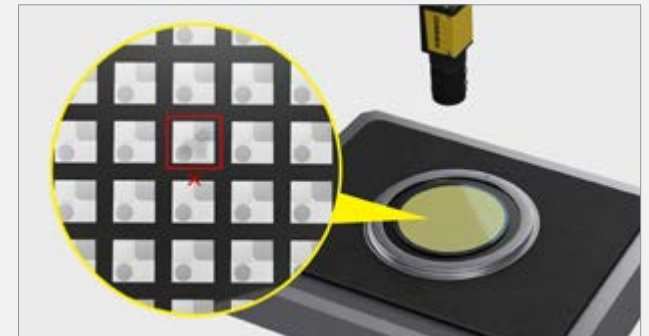

Electronics



Life sciences



Packaging

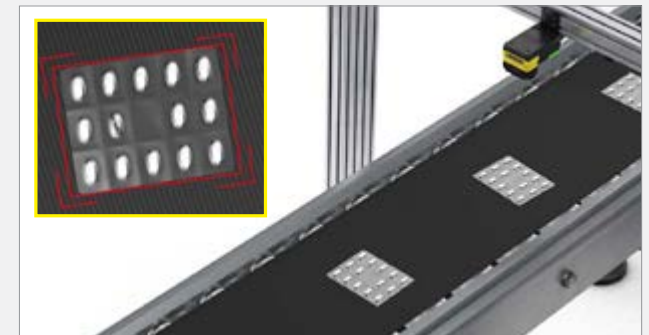

Pharmaceutical

COGNEX GLOBAL SERVICES

Cognex serves an international customer base from offices located throughout the Americas, Europe, and Asia and through a global network of highly-trained partners, system integrators, and distributors.

From development to deployment, Cognex is there to get your vision systems up and running as fast as possible. Whether you're considering machine vision for the first time or are already an expert user, Cognex global services provide the expertise to help your organization succeed.

cognex.com/support/cognex-services

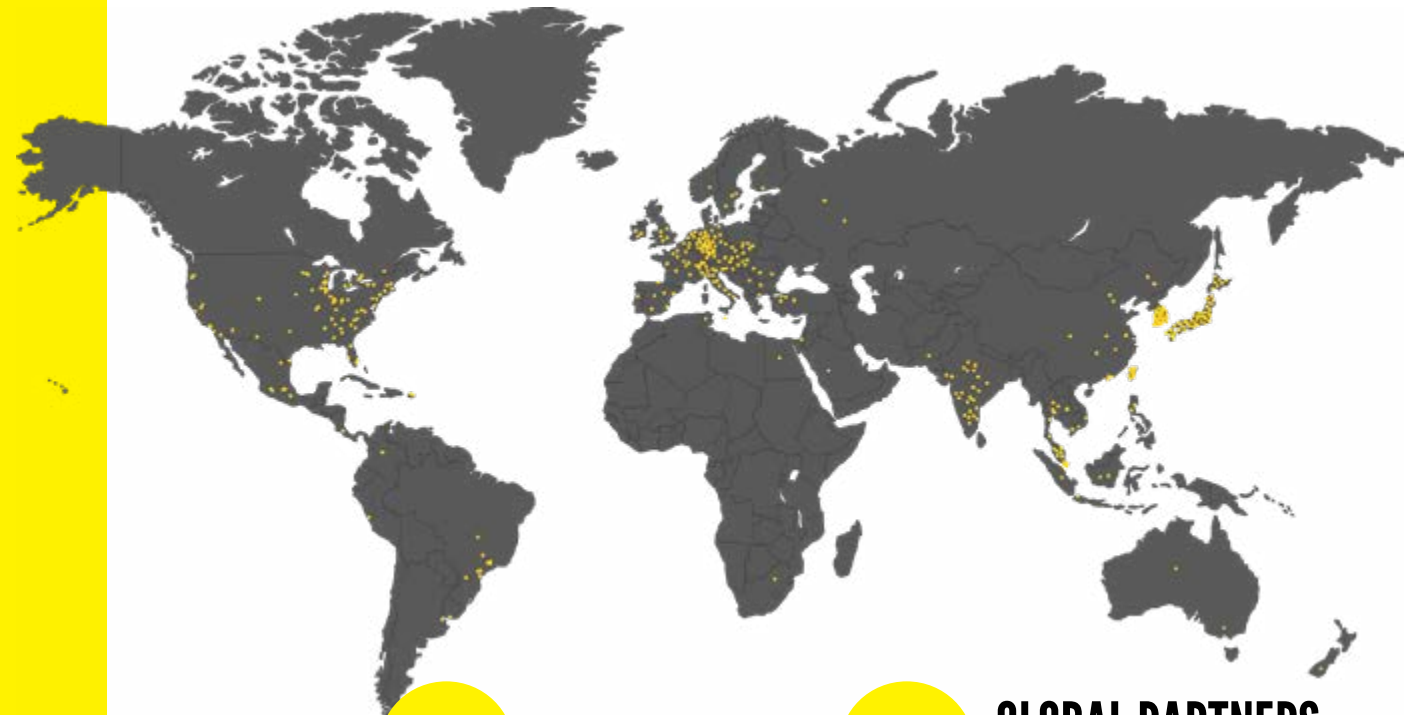
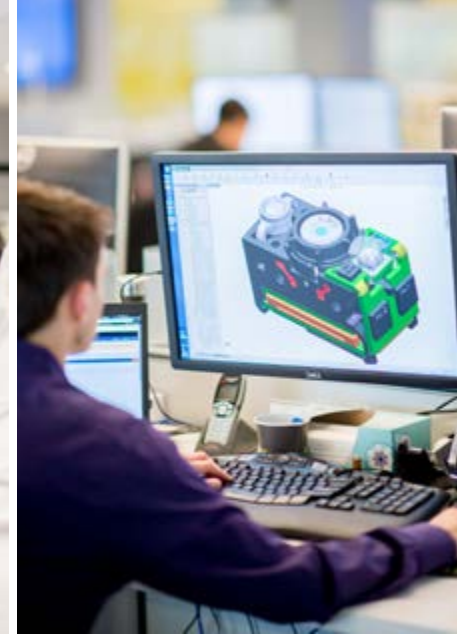

OFFICES IN **20+** COUNTRIES

500+ GLOBAL PARTNERS
IN 30 COUNTRIES



TECHNICAL SUPPORT

All Cognex products come with complimentary technical support during and after installation from experienced vision engineers that you can access by phone, email, and online knowledge database. Cognex engineers can remotely connect to your system to help solve your problem. Cognex vision systems come with a one-year limited warranty and are covered by our Hot Swap Program, which guarantees shipment of a permanent replacement system within 2 business days of a reported failure.

cognex.com/support

THE MOST EXTENSIVE VISION NETWORK

Around the globe, wherever you find manufacturing, you can find a Cognex representative! Our extensive network of Cognex certified partners consist of the most experienced Automation Service Providers (ASPs) and Certified System Integrators (CSIs) in the industry.

Our ASPs are locally-based vision suppliers offering a wide range of factory automation products, support and services to Cognex customers around the world. Additionally, when it comes to more complex automation installations that require highly skilled resources, our CSIs offer an extensive range of services including completely customized automation solutions to integration into pre-existing solutions.

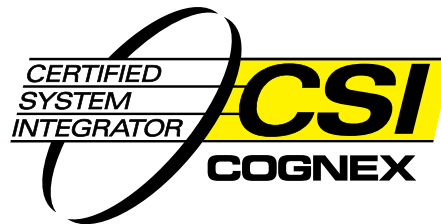



COGNEX TRAINING

We want to make you the most effective vision professional at your organization. That's why Cognex offers a variety of training options dedicated to increasing organizational expertise and optimizing your manufacturing processes. Through our global training program, we deliver a variety of courses for beginners to advanced users that range from the fundamentals of machine vision to real-world applications for complex tools.

CUSTOMIZED, ANYTIME

For groups of six or more, Cognex classes are available at your facility so that your team can work and learn together in your operating environment. For convenience, the Cognex online training portal lets you access on-demand training videos of Cognex courses, participate in virtual classes and tutorials, and view application examples.

By combining key training classes and system integration services into training service packages, Cognex helps focus and accelerate your learning.

cognex.com/training



10,000+
ATTENDEES IN 2022



1000+
WORLDWIDE
CLASSES IN 2022



18
DIFFERENT LANGUAGES

WHAT DOES CULTURE MEAN AT COGNEX?

WORK HARD

We are passionate about our work. We work hard because we are empowered to make a difference.

PLAY HARD

Jump out of an airplane with our CEO? Get in a paint fight with your coworkers? Launch pumpkins from a catapult for prizes? Or just drink beer with friends at an after-work social. Cognex goes all out to reward working hard with creative opportunities to play hard.

MOVE FAST

The sooner we test that new idea, the sooner we can bring it to market to help our customers meet their goals. Staying nimble keeps work interesting, and keeps Cognex innovating.



COGNEX

WWW.COGNEX.COM

COGNEX

Companies around the world rely on Cognex vision and barcode reading solutions to optimize quality, drive down costs and control traceability.

Corporate Headquarters One Vision Drive Natick, MA 01760 USA

Regional Sales Offices

Americas

North America +1 844 999 2469
Brazil +55 11 4210 3919
Mexico +800 733 4116

Europe

Austria +43 800 28 16 32
Belgium +32 289 370 75
Czechia +420 800 023 519
France +33 1 76 54 93 18
Germany +49 721 958 8052
Hungary +36 800 80291

Ireland +353 21 421 7500
Italy +39 02 3057 8196
Netherlands +31 207 941 398
Poland +48 717 121 086
Romania +40 741 041 272
Spain +34 93 299 28 14
Sweden +46 21 14 55 88
Switzerland +41 445 788 877
Turkey +90 216 900 1696
United Kingdom +44 121 29 65 163

Asia-Pacific

Australia +61 2 7202 6910
China +86 21 2279 9455

India +91 7305 040397
Indonesia +62 21 3076 1792
Japan +81 3 5977 5400
Korea +82 2 539 9047
Malaysia +6019 916 5532
New Zealand +64 9 802 0555
Phillipines +63 2 8539 3990
Singapore +65 3158 3322
Taiwan +886 02 7703 2848
Thailand +66 6 3230 9998
Vietnam +84 98 2405167

© Copyright 2023, Cognex Corporation. All information in this document is subject to change without notice. All Rights Reserved. Cognex, In-Sight, EasyBuilder, VisionPro, and DataMan are registered trademarks of Cognex Corporation. 1D/2D QuickSort is a trademark of Cognex Corporation. All other trademarks are property of their respective owners. Lit. No. CPG-EN-04-2023