

WORLD-BEAM® QS18E Clear Object Detection with I O-Link

Instruction Manual

Original Instructions
196873 Rev. A
10 January 2017
© Banner Engineering Corp. All rights reserved



196873

Contents

1	Product Description	3
1.1	Models	3
1.2	Overview	4
2	Installation	5
2.1	Installing and Mounting the Sensor for Low Contrast Applications	5
2.2	Wiring Diagrams	5
3	Sensor Configuration	7
3.1	Push Button Configuration	7
3.2	Remote Input Configuration	7
4	Select Sensing Mode	9
4.1	Transparent Mode Set	9
4.2	Film Mode Set	10
4.3	Opaque Mode Set	11
5	IO-Link Interface	13
6	Specifications	14
6.1	Dimensions	15
6.2	Performance Curves	15
7	Accessories	16
7.1	Cordsets	16
7.2	Retroreflectors	16
7.3	Brackets	17
8	Contact Us	19
9	Banner Engineering Corp. Limited Warranty	20

1 Product Description

Expert™ Coaxial Polarized Retroreflective Sensor for Clear Object Detection with IO-Link

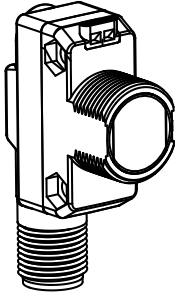

- Reliably detects clear, transparent, or opaque objects — including PET, glass containers, and transparent films
- Coaxial optics enable reliable detection of targets to the face of the sensor with no dead zone
- ClearTracking automatic compensation algorithm provides long and reliable operation by compensating for dust build up and ambient temperature changes
- Fast response speed with low jitter for high speed bottling and packaging applications
- Bright, visible red light spot makes alignment easy
- 3 user-selectable thresholds optimize performance to the type of object being detected
- Easy configuration of sensor by remote teach input or tactile push button
- Convenient mounting options available for 18 mm barrel or side mount
- Bright indicator LEDs show operating status from 360°
- IP67 rated ABS housing
- IO-Link with programmable PNP/NPN output and input configurations using IO-Link



WARNING: Not To Be Used for Personnel Protection

Never use this device as a sensing device for personnel protection. Doing so could lead to serious injury or death. This device does not include the self-checking redundant circuitry necessary to allow its use in personnel safety applications. A sensor failure or malfunction can cause either an energized or de-energized sensor output condition.

1.1 Models

Model	Mode	Range	Channel 1	Channel 2	Connector ¹
QS18EK6XLPC		0 to 1.3 m (0 to 4.2 ft) on BRT-40X19A 0 to 2.0 m (0 to 6.5 ft) on BRT-60X40C 0 to 3.0 m (0 to 9.8 ft) on BRT-92X92C	IO-Link, Push/pull output, programmable PNP or NPN output	Multi-function remote input/output, programmable PNP or NPN	2 m (6.5 ft) cable

¹ Integral 2 m (6.5 ft) unterminated cable models are listed.

- To order the 9 m (30 ft) PVC cable model, add the suffix "W/30" to the cabled model number. For example, QS18EK6XLPC W/30.
- To order the 4-pin M12/Euro-style integral quick disconnect model, add the suffix "Q8" to the model number. For example, QS18EK6XLPCQ8.
- To order the 150 mm (6 in) PVC cable model with a 4-pin M12/Euro-style quick disconnect, add the suffix "Q5" to the model number. For example, QS18EK6XLPCQ5.
- To order the 4-pin M8/Pico-style integral quick disconnect model, add the suffix "Q7" to the model number. For example, QS18EK6XLPCQ7.
- To order the 150 mm (6 in) PVC cable model with a 4-pin M8/Pico-style quick disconnect, add the suffix "Q" to the model number. For example, QS18EK6XLPCQ.

1.2 Overview

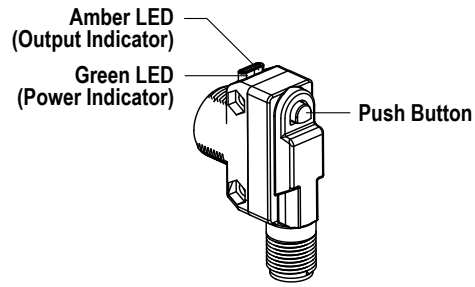

The Banner QS18 sensor is a high performance clear object detection sensor with an IO-link and multifunction output. The polarized coaxial optical design ensures reliable detection of transparent, translucent, and opaque targets at any distance between the sensor and the reflector. Low contrast sensing applications include PET bottles, glass containers, and shrink wrap. The sensor can also be used to detect optical surfaces such as: LCD panels with built in polarizing films, solar panels, and semiconductor wafers.

Indicators (Two LEDs: One Green, One Amber)		
Sensor Condition (Run Mode)	Green LED	Amber LED
Output OFF	ON	OFF
Output ON	ON	ON
Notification — Sensor needs to be reconfigured for reliable detection	Flashing at 5 Hz	ON/OFF
Notification — Push button has been locked out	Flashes 4 times and returns to solid on	ON/OFF

2 Installation

2.1 Installing and Mounting the Sensor for Low Contrast Applications

Reliable transparent object detection depends on the sensor always detecting the object as "dark state" and the reflector as the "light state". Using a recommended reflector, and proper orientation of the sensor to the reflector, is key to good clear object detection. Optimize the reliable detection of transparent and clear objects by applying the following steps when mounting the sensor and selecting a retroreflective target.

1. If a bracket is needed, mount the sensor onto the bracket.
2. Mount the sensor (or the sensor and the bracket) to the equipment at the desired location. Do not tighten at this time.
3. Align the sensor's light spot to the middle of the retroreflector.
4. Mount the retroreflector perpendicular to the sensor optical axis ($\pm 5^\circ$).
5. Tighten the screws to secure the sensor (or the sensor and the bracket) to the aligned position.

2.1 Mounting Considerations for Opaque Objects with Mirror Like Surfaces

To minimize the potential for reflections from mirror like objects affecting the sensor, it is best to side mount the sensor.

2.2 Wiring Diagrams

IO-Link with PNP Output (Factory Default)

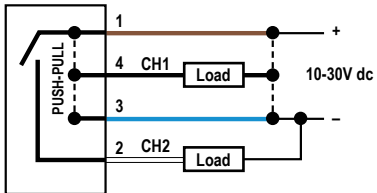

Figure 1. Channel 1 = IO-Link, Channel 2 = PNP Output

IO-Link with PNP Remote Input

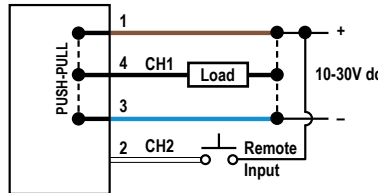

Figure 2. Channel 1 = IO-Link, Channel 2 = PNP Remote Input

Key

1. Brown
2. White
3. Blue
4. Black



NOTE: NPN/PNP and Remote Input configurations are programmable using IO-Link.



NOTE: The remote input wire function needs to be enabled using IO-Link. The default for the remote input wire function is Detection Output.

NPN Discrete Outputs

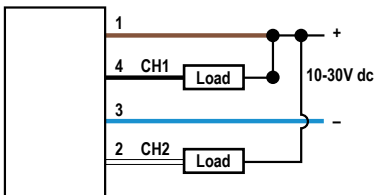

Figure 3. Channel 1 = NPN Output, Channel 2 = NPN Output

PNP Discrete Outputs

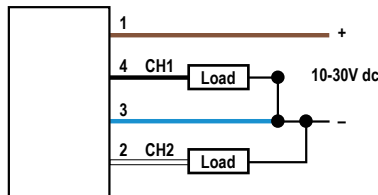

Figure 4. Channel 1 = PNP Output, Channel 2 = PNP Output

NPN Output and Remote Input

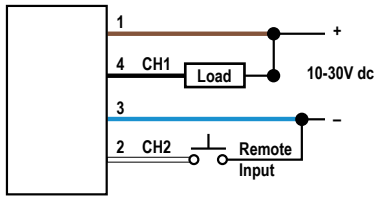

Figure 5. Channel 1 = NPN Output, Channel 2 = NPN Remote Input

PNP Output and Remote Input

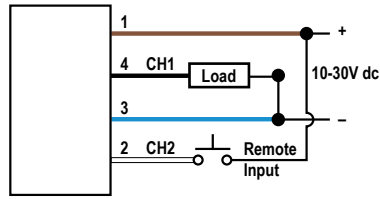

Figure 6. Channel 1 = PNP Output, Channel 2 = PNP Remote Input

3 Sensor Configuration

Sensor configuration can be performed using IO-Link, the push button, or the remote input wire once enabled through IO-link. Options include three sensing modes: Transparent, Film, and Opaque. Other configuration options include: output delay timing, health output, offset percentages, and the ClearTracking auto compensation algorithm. For more detail, see the IO-Link IODD package (p/n 198215), which includes an IO-Link Data Map, on the Banner Website at <http://www.bannerengineering.com>.

3.1 Push Button Configuration

Use the push button to configure the sensor. Click the push button according to Push Button Input Flowchart. After a configuration has been selected the sensor flashes both the green and amber LED to show which configuration was selected followed by a rapid flashing of both the green and amber LED in unison to show acknowledgement and acceptance of the configuration.

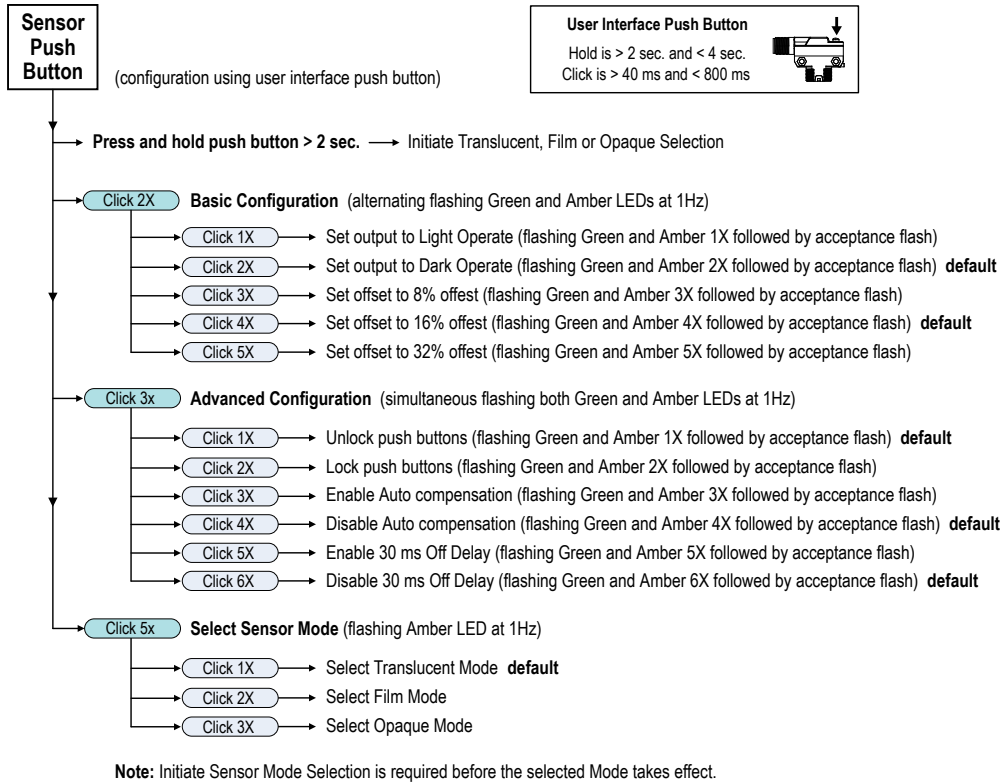

Figure 7. Push Button Input Flowchart

3.2 Remote Input Configuration

Enabling the remote input wire is done using IO-Link. Use the remote input function to configure the sensor remotely. Connect the white wire of the sensor as shown in the wiring diagram. Pulse the remote line according to the Remote Input Flowchart. After a configuration has been selected, both the green and amber LEDs will flash to show which configuration was selected, followed by a rapid flashing of both the green and amber LED in unison to show acknowledgement and acceptance of the configuration.

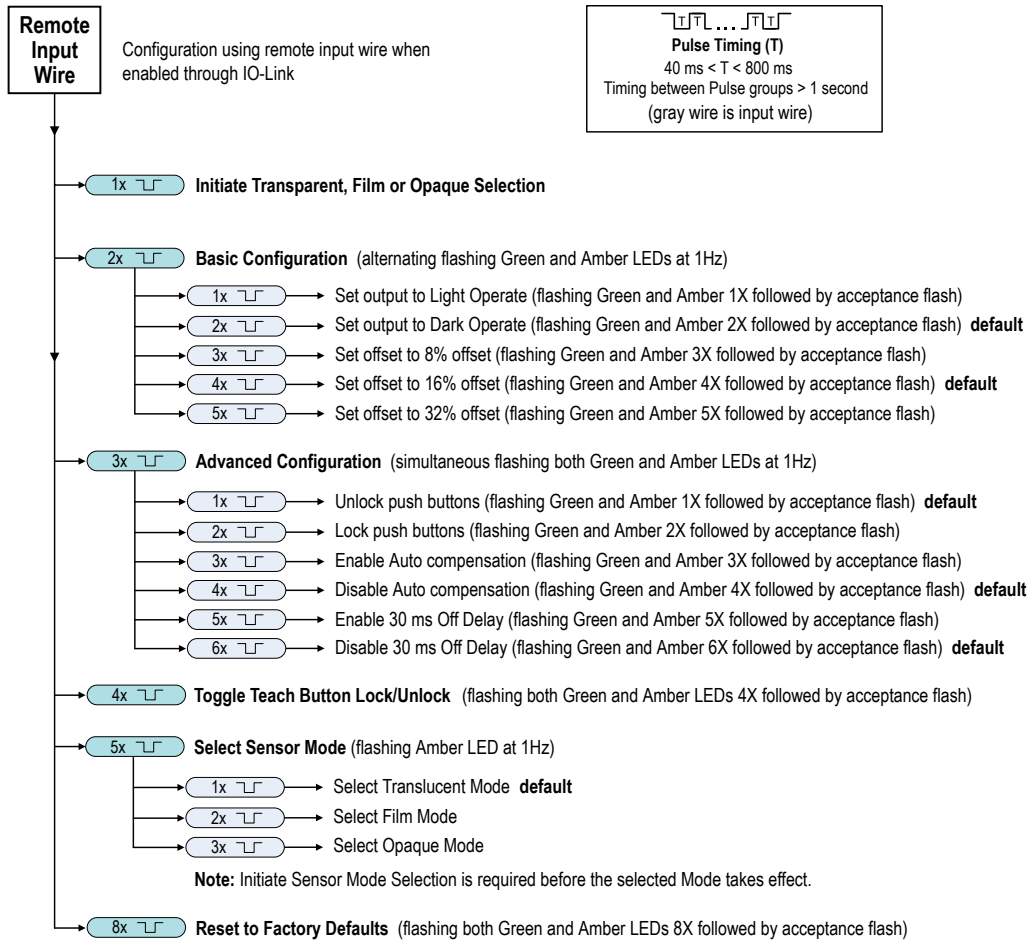

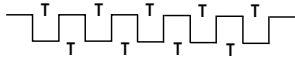

Figure 8. Remote Input Flowchart







4 Select Sensing Mode

By default, the sensing mode is set to Transparent. To select either Film or Opaque mode, follow these steps.

1. Access the Select Sensing Mode.

Method	Action		Result
Push Button	Click the button 5-times.		Select Sensing Mode enabled (Amber LED flashes at 1 Hz).
Remote Line	Pulse the remote line 5-times.		

2. Select the desired sensing mode.

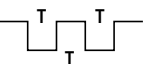
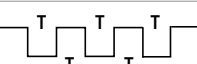
Method	Sensing Mode	Action		Result
Push Button	Transparent	Click the button 1-time.		The selected sensing mode is enabled.
	Film	Click the button 2-times.		
	Opaque	Click the button 3-times.		
IO-Link	Transparent	Set BDC1 Mode using IO-Link.	 IO-Link®	
	Film	Set BDC1 Mode using IO-Link.	 IO-Link®	
	Opaque	Set BDC1 Mode using IO-Link.	 IO-Link®	
Remote Line	Transparent	Pulse the remote line 1-time.		
	Film	Pulse the remote line 2-times.		
	Opaque	Pulse the remote line 3-times.		

4.1 Transparent Mode Set

Use Transparent mode for low contrast applications where the object is not present during the teach process. Transparent mode is the default sensing mode and is best for most clear object detection applications.

Example Applications For Offset Percentages	
8%	Recommended for very low contrast applications with stable environmental conditions.
16%	Recommended for most clear object detection applications in typical machine industrial environments.
32%	Recommended for high contrast detections such as brown or green bottles, or opaque objects. This setting tolerates environmental challenges such as vibrations and dust build-up.

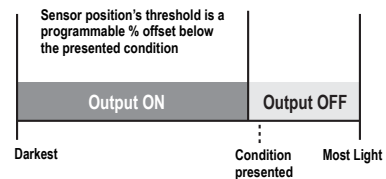
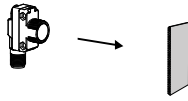

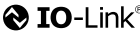



Figure 9. Transparent Mode

1. Prepare the sensor.

Method	Action	Result
Push Button, IO-Link, and Remote Line	Clear the light path to the reflector.	

2. Access Transparent mode and set the sensing condition.

Method	Action	Result
Push Button	Press and hold the button 2 to 4 seconds. 	<u>Transparent Mode Configuration Accepted</u> Green LED Indicator: Flashes 3 times.
IO-Link	Send Single Value Teach command using IO-Link. 	Green and Amber LED Indicators: Acceptance Flash—both LEDs flash 5 times rapidly in unison. The sensor returns to Run mode with Transparent mode as the sensing condition.
Remote Line	Pulse the remote line 1-time. 	<u>Transparent Mode Configuration Not Accepted</u> If there is not enough return signal the sensor will perform an Opaque mode configuration indicated by: Green and Amber LED Indicators: Flash 2 times. Green and Amber LED Indicators: Acceptance Flash—both LEDs flash 5 times rapidly in unison and the Green LED will continue to flash. The sensor is not ready for transparent detection due to insufficient light from the reflector, but is ready for maximum range Opaque object detection. Re-optimize alignment, check the reflector size for required range, and re-configure the sensor for transparent object detection.

4.2 Film Mode Set

Film mode is useful when the transparent target cannot be removed from the light path during the teach procedure. This is common on continuous web processes such as shrink wrapping machinery. The sensor learns the dark state with the web present and switches the output if the web breaks or runs out.

Example Applications For Offset Percentages	
8%	Recommended for very low contrast applications with stable environmental conditions.
16%	Recommended for most clear object detection applications in typical machine industrial environments.
32%	Recommended for high contrast detections such as brown or green bottles, or opaque objects. This setting tolerates environmental challenges such as vibrations and dust build-up.

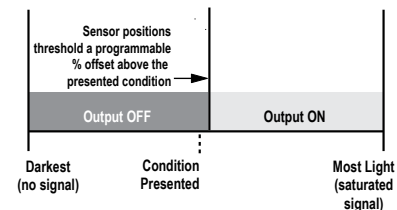
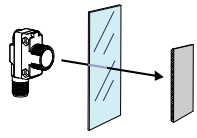





Figure 10. Film Mode

1. Prepare the sensor.

Method	Action	Result
Push Button, IO-Link, and Remote Line	Align the light path to the reflector through a plastic film.	

2. Access Film mode and set the sensing condition.

Method	Action	Result
Push Button	Press and hold the button 2 to 4 seconds. 	<u>Film Mode Configuration Accepted</u> Green LED Indicator: Flashes 3 times.
IO-Link	Send Single Value Teach command using IO-Link. 	Green and Amber LED Indicators: Acceptance Flash - both LEDs flash 5 times rapidly in unison. The sensor returns to Run mode with Film mode as the sensing condition.
Remote Line	Pulse the remote line 1-time. 	<u>Film Mode Configuration Not Accepted</u> If there is not enough return signal the sensor will perform an Opaque mode configuration indicated by: Green and Amber LED Indicators: Flash 2 times. Green and Amber LED Indicators: Acceptance Flash - both LEDs flash 5 times rapidly in unison and the Green LED will continue to flash. The sensor is not ready for film detection due to insufficient light from the reflector, but is ready for maximum range Opaque object detection. Re-optimize alignment, check the reflector size for required range, and re-configure the sensor for film detection.

4.3 Opaque Mode Set

Opaque mode is recommended for long range detection of opaque (light blocking) targets. When Opaque mode is used, the sensor operates at maximum sensing range regardless of the taught condition.



NOTE: The sensor's light spot is made brighter for 60 seconds to assist in aligning the sensor to the reflector. This is particularly useful for long range applications.

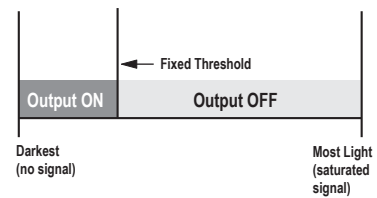
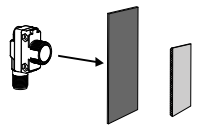

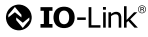



Figure 11. Opaque Mode

1. Prepare the sensor.

Method	Action	Result
Push Button, IO-Link, and Remote Line	Present either the clear light path or blocked light path. Both are acceptable.	

2. Access Opaque mode and set the sensing condition.

Method	Action		Result
Push Button	Press and hold the button 2 to 4 seconds.		<u>Opaque Mode Configuration Accepted</u> Green LED Indicator: Flashes 3 times.
IO-Link	Send Single Value Teach command using IO-Link.		Green and Amber LED Indicators: Acceptance Flash - both LEDs flash 5 times rapidly in unison, and the Green LED is on solid.
Remote Line	Pulse the remote line 1-time.		The sensor returns to Run mode with high excess gain settings.

5 IO-Link Interface

IO-Link is a point-to-point communication link between a master device and sensor. It can be used to automatically parameterize sensors and transmit process data. For the latest IO-Link protocol and specifications, please visit the web site at <http://www.io-link.com>.

The IO-Link IODD package (P/N 198215) is contained on the Banner Website at <http://www.bannerengineering.com>.

6 Specifications

Supply Voltage and Current

10 V dc to 30 V dc (10% max. ripple) at 30 mA

Repeatability

100 µs

Supply Protection Circuitry

Protected against reverse polarity and transient overvoltages

Output Protection Circuitry

Protected against false pulse on power-up and continuous overload or short-circuit of output

Output Configuration

Channel 1: IO-Link, Push/pull output, configurable PNP or NPN output
Channel 2: Multi-function remote input/output, configurable PNP or NPN

Output Response Time

Momentary delay on power-up, < 0.5 s, output does not conduct during this period
400 µs ON/OFF

IO-Link Interface

Supports Smart Sensor Profile: Yes

Baud Rate: 38400 bps

Process Data Widths: 16 bits

IO-Link Files: Provides all programming options of button and remote input wire, plus additional functionality. Please see the IO-Link Datamap document for more details.

Emitter LED

Visible red, 625 nm

Indicators

Two LEDs (1 green, 1 amber)

Green solid: Indicates power applied and sensor ready

Green flashing: Indicates sensor operating in marginal state, in need of reconfiguration

Amber solid: Indicates output conducting

Factory Default Settings

Setting	Factory Default
Sensing Mode	Transparent Mode
Output Logic	Dark Operate
Offset Percent	16%
Push Button	Unlocked
Auto Compensation	Disabled
OFF Delay	Disabled
Pin 4 Output	IO-Link Enabled Detection Output (Push-pull)
Pin 2 Output	Detection Output: High speed output when using IO-Link on Pin 4 (PNP)

Required Overcurrent Protection



WARNING: Electrical connections must be made by qualified personnel in accordance with local and national electrical codes and regulations.

Overcurrent protection is required to be provided by end product application per the supplied table.

Overcurrent protection may be provided with external fusing or via Current Limiting, Class 2 Power Supply.

Supply wiring leads < 24 AWG shall not be spliced.

For additional product support, go to www.bannerengineering.com.

Supply Wiring (AWG)	Required Overcurrent Protection (Amps)
20	5.0
22	3.0
24	2.0
26	1.0
28	0.8
30	0.5

Construction

ABS housing, PMMA window

Mounting Torque

Nose mount: 18 mm mounting nut, 20 lbf-in (2.3 N-m)

Side mount: Two M3 screws, 5 lbf-in (0.6 N-m)

Connections

PVC-jacketed 4-conductor 2 m (6.5 ft) or 9 m (30 ft) unterminated cable, or 4-pin Euro-style or 4-pin Pico-style quick-disconnect (QD), either integral or 150 mm (6 in) pigtail, are available. QD cordsets are ordered separately.

Operating Conditions

-40 °C to +70 °C (-40 °F to +158 °F)

95% at +50 °C maximum relative humidity (non-condensing)

Environmental Rating

IEC IP67

Application Notes

If the push button does not appear to be responsive, perform the push button enable procedure

Certifications



6.1 Dimensions

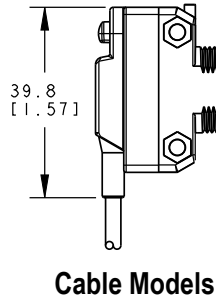
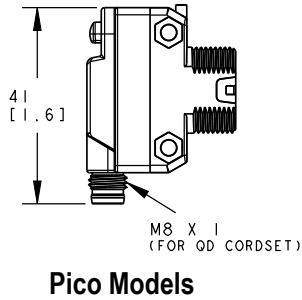
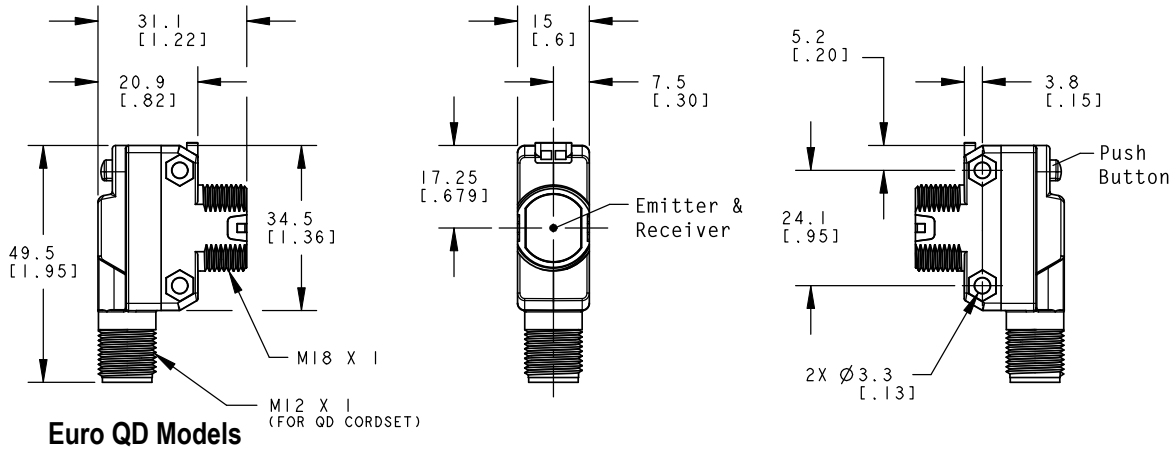

6.2 Performance Curves

Spot Size vs. Distance

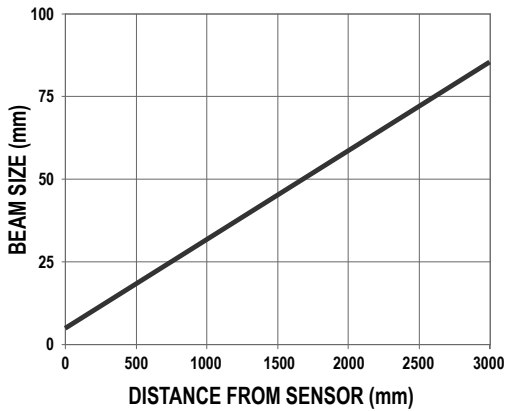

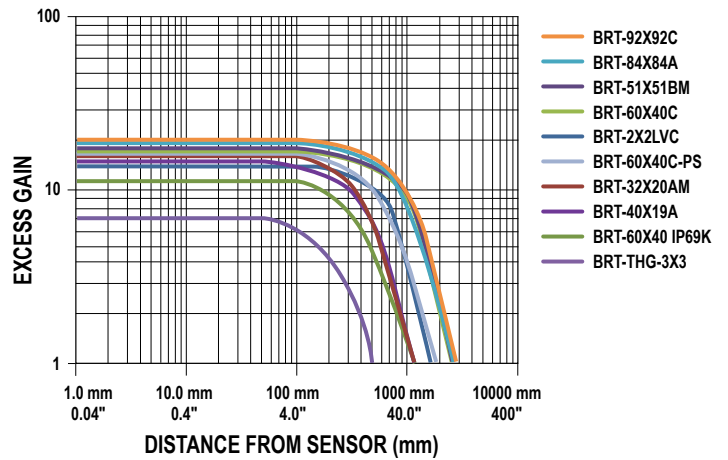

Excess Gain

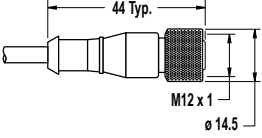
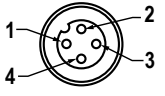
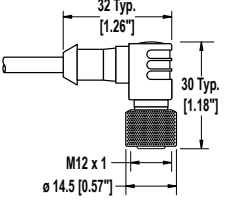

7 Accessories

7.1 Cordsets

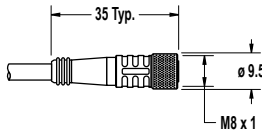
4-Pin Threaded M12/Euro-Style Cordsets				
Model	Length	Style	Dimensions	Pinout (Female)
MQDC-406	1.83 m (6 ft)	Straight		
MQDC-415	4.57 m (15 ft)			
MQDC-430	9.14 m (30 ft)			
MQDC-450	15.2 m (50 ft)			
MQDC-406RA	1.83 m (6 ft)	Right-Angle		1 = Brown 2 = White 3 = Blue 4 = Black
MQDC-415RA	4.57 m (15 ft)			
MQDC-430RA	9.14 m (30 ft)			
MQDC-450RA	15.2 m (50 ft)			

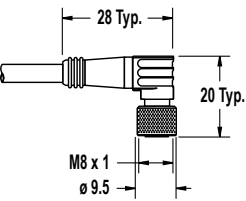
4-Pin Threaded M8/Pico-Style Cordsets				
Model	Length	Style	Dimensions	Pinout (Female)
PKG4M-2	2 m (6.56 ft)	Straight		
PKG4M-5	5 m (16.4 ft)			
PKG4M-9	9 m (29.5 ft)			
PKW4M-2	2 m (6.56 ft)	Right Angle		1 = Brown 2 = White 3 = Blue 4 = Black
PKW4M-5	5 m (16.4 ft)			
PKW4M-9	9 m (29.5 ft)			

7.2 Retroreflectors

BRT-51X51BM

- Square, acrylic target
- Reflectivity Factor: 1.5
- Temperature: -20 °C to +50 °C (-4 °F to +122 °F)
- Micro-prism geometry
- Optional brackets are available
- Approximate size: 51 mm × 51 mm

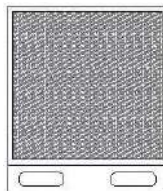

BRT-60X40C

- Rectangular, acrylic target
- Reflectivity Factor: 1.4
- Temperature: -20 °C to +60 °C (-4 °F to +140 °F)
- Optional brackets are available
- Approximate size: 40 mm × 60 mm

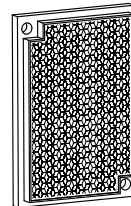

BRT-92X92C

- Square, acrylic target
- Reflectivity Factor: 3.0
- Temperature: -20 °C to +60 °C (-4 °F to +140 °F)
- Optional brackets are available
- Approximate size: 92 mm x 92 mm



BRT-40X19A

- Rectangular, acrylic target
- Reflectivity Factor: 1.3
- Temperature: -20 °C to +60 °C (-4 °F to +140 °F)
- Approximate size: 19 mm x 60 mm overall; 19 mm x 40 mm reflector

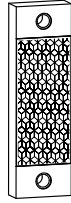

BRT-60X40IP69K

- Rectangular, acrylic target (color is amber)
- Reflectivity Factor: 0.7
- Temperature: -20 °C to +140 °C (-4 °F to +284 °F)
- Chemically resistant
- IP69K washdown rated
- Optional brackets are available
- Approximate size: 40 mm x 60 mm

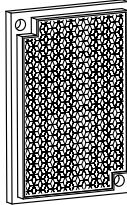

BRT-60X40C-PS

- Rectangular, polystyrene target
- Reflectivity Factor: 1.1
- Temperature: -20 °C to +60 °C (-4 °F to +140 °F)
- Optional brackets are available
- Chemically compatible with hydrogen peroxide
- Yellow back
- Approximate size: 40 mm x 60 mm

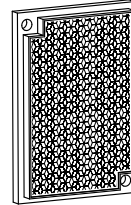

2 in retroreflective tape, 2.5 m (100 in)

Model	Reflectivity Factor	Maximum Temperature	Size
BRT-THG-2-100	0.7	+60 °C (+140 °F)	50 mm (2 in) wide, 2.5 m (100 in) long

7.3 Brackets

SMB18A

- Right-angle mounting bracket with a curved slot for versatile orientation
- 12-ga. stainless steel
- 18 mm sensor mounting hole
- Clearance for M4 (#8) hardware

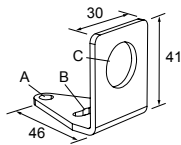

Hole center spacing: A to B = 24.2
 Hole size: A = \varnothing 4.6, B = 17.0 x 4.6, C = \varnothing 18.5

SMBQS18Y

- Die-cast bracket for 18 mm holes
- Includes metal hex nut and lock washer
- Allows $\pm 8^\circ$ for cabled sensors

Hole size: A = \varnothing 15.3

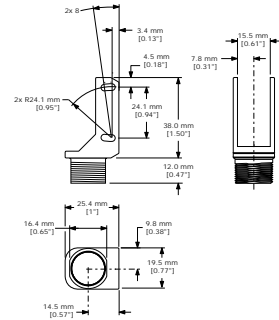

SMBQ4X..

- Swivel bracket with tilt and pan movement for precision adjustment
- Easy sensor mounting to extruded rail T-slots
- Metric and inch size bolts available
- Side mounting of some sensors with the 3 mm screws included with the sensor

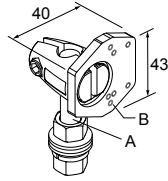

B = 7 × M3 × 0.5

Model	Bolt Thread (A)
SMBQ4XF4	3/8 - 16 × 2¼ in
SMBQ4XFAM10	M10 - 1.5 × 50
SMBQ4XFAM12	n/a; no bolt included. Mounts directly to 12 mm (½ in) rods

SMB18AFA..

- Protective, swivel bracket with tilt and pan movement for precision adjustment
- Easy sensor mounting to extruded rail T-slots
- Metric and inch size bolts available
- Mounting hole for 18 mm sensors

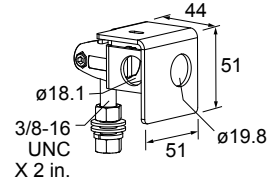

Hole size: B = ø 18.1

Model	Bolt Thread (A)
SMB18AFA	3/8 - 16 × 2 in
SMB18AFAM10	M10 - 1.5 × 50

SMB312S

- Stainless steel 2-axis, side-mount bracket

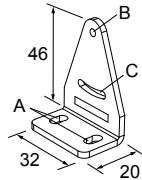

A = 4.3 × 7.5, B = diam. 3, C = 3 × 15.3

8 Contact Us

Corporate Headquarters

Address:
Banner Engineering Corporate
9714 Tenth Avenue North
Minneapolis, Minnesota 55441, USA

Phone: +1 763 544 3164
Website: www.bannerengineering.com

Europe

Address:
Banner Engineering EMEA
Park Lane Culliganlaan 2F
Diegem B-1831, Belgium

Phone: +32 (0)2 456 0780
Website: www.bannerengineering.com/eu
Email: mail@bannerengineering.com

Turkey

Address:
Banner Engineering Turkey
Barbaros Mah. Uphill Court Towers A Blok D: 49
34746 Batı Ataşehir İstanbul Türkiye

Phone: +90 216 688 8282
Website: www.bannerengineering.com.tr
Email: turkey@bannerengineering.com.tr

India

Address:
Banner Engineering India Pune Head Quarters
Office No. 1001, 10th Floor Sai Capital, Opp. ICC Senapati Bapat Road
Pune 411016, India

Phone: +91 (0) 206 640 5624
Website: www.bannerengineering.co.in
Email: salesindia@bannerengineering.com

Mexico

Address:
Banner Engineering de Mexico Monterrey Head Office
Edificio VAO Av. David Alfaro Siqueiros No.103 Col. Valle Oriente C.P.66269
San Pedro Garza Garcia, Nuevo Leon, Mexico

Phone: +52 81 8363 2714 or 01 800 BANNERE (toll free)
Website: www.bannerengineering.com.mx
Email: mexico@bannerengineering.com

Brazil

Address:
Banner do Brasil
Rua Barão de Teffé nº 1000, sala 54
Campos Eliseos, Jundiaí - SP, CEP.: 13208-761, Brasil

Phone: +1 763 544 3164
Website: www.bannerengineering.com.br
Email: brasil@bannerengineering.com

China

Address:
Banner Engineering Shanghai Rep Office
Xinlian Scientific Research Building Level 12, Building 2
1535 Hongmei Road, Shanghai 200233, China

Phone: +86 212 422 6888
Website: www.bannerengineering.com.cn
Email: sensors@bannerengineering.com.cn

Japan

Address:
Banner Engineering Japan
Cent-Urban Building 305 3-23-15 Nishi-Nakajima Yodogawa-Ku
Osaka 532-0011, Japan

Phone: +81 (0)6 6309 0411
Website: www.bannerengineering.co.jp
Email: mail@bannerengineering.co.jp

Taiwan

Address:
Banner Engineering Taiwan
8F-2, No. 308 Section 1, Neihu Road
Taipei 114, Taiwan

Phone: +886 (0)2 8751 9966
Website: www.bannerengineering.com.tw
Email: info@bannerengineering.com.tw

9 Banner Engineering Corp. Limited Warranty

Banner Engineering Corp. warrants its products to be free from defects in material and workmanship for one year following the date of shipment. Banner Engineering Corp. will repair or replace, free of charge, any product of its manufacture which, at the time it is returned to the factory, is found to have been defective during the warranty period. This warranty does not cover damage or liability for misuse, abuse, or the improper application or installation of the Banner product.

THIS LIMITED WARRANTY IS EXCLUSIVE AND IN LIEU OF ALL OTHER WARRANTIES WHETHER EXPRESS OR IMPLIED (INCLUDING, WITHOUT LIMITATION, ANY WARRANTY OF MERCHANTABILITY OR FITNESS FOR A PARTICULAR PURPOSE), AND WHETHER ARISING UNDER COURSE OF PERFORMANCE, COURSE OF DEALING OR TRADE USAGE.

This Warranty is exclusive and limited to repair or, at the discretion of Banner Engineering Corp., replacement. IN NO EVENT SHALL BANNER ENGINEERING CORP. BE LIABLE TO BUYER OR ANY OTHER PERSON OR ENTITY FOR ANY EXTRA COSTS, EXPENSES, LOSSES, LOSS OF PROFITS, OR ANY INCIDENTAL, CONSEQUENTIAL OR SPECIAL DAMAGES RESULTING FROM ANY PRODUCT DEFECT OR FROM THE USE OR INABILITY TO USE THE PRODUCT, WHETHER ARISING IN CONTRACT OR WARRANTY, STATUTE, TORT, STRICT LIABILITY, NEGLIGENCE, OR OTHERWISE.

Banner Engineering Corp. reserves the right to change, modify or improve the design of the product without assuming any obligations or liabilities relating to any product previously manufactured by Banner Engineering Corp. Any misuse, abuse, or improper application or installation of this product or use of the product for personal protection applications when the product is identified as not intended for such purposes will void the product warranty. Any modifications to this product without prior express approval by Banner Engineering Corp will void the product warranties. All specifications published in this document are subject to change; Banner reserves the right to modify product specifications or update documentation at any time. Specifications and product information in English supersede that which is provided in any other language. For the most recent version of any documentation, refer to: www.bannerengineering.com.