

# Q45X Series Sensors

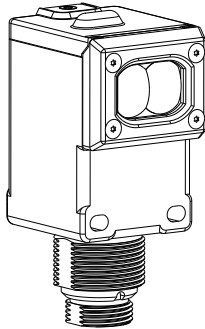

## Datasheet

Photoelectric sensors with expansion slot for DeviceNet™ compatibility



- Low cost photoelectric sensors with unique expansion slot to allow instant sensor upgrading at any time
- Expansion cards for DeviceNet™ network interfaces and sensor performance displays
- Basic sensor directly interfaces to PLCs, relays, and other logic-level loads
- Easy "smart sensor" interfacing to data bus network by simply selecting the appropriate plug-in card and cable for the popular bus protocol DeviceNet
- 10 V dc to 30 V dc operation; integral mini-style quick-disconnect connector
- Highly-visible sensor status and performance LEDs
- Tough mechanical design withstands 1200 psi washdown



**WARNING:**

- **Do not use this device for personnel protection**
- Using this device for personnel protection could result in serious injury or death.
- This device does not include the self-checking redundant circuitry necessary to allow its use in personnel safety applications. A device failure or malfunction can cause either an energized (on) or de-energized (off) output condition.

## Models

Model	Sensing Mode	Beam	Sensing Range
Q45X6EQ	Opposed emitter	Infrared, 880 nm	60 m (200 ft)
Q45XB6RQ	Opposed receiver		
Q45XB6LVQ	Retroreflective	Visible red, 680 nm	9 m (30 ft)
Q45XB6LPQ	Polarized retro		6 m (20 ft)
Q45XB6DQ	Short-range diffuse	Infrared, 880 nm	450 mm (18 in)
Q45XB6DLQ	Long-range diffuse		1.8 m (6 ft)
Q45XB6CVQ	Convergent	Visible red, 680 nm	38 mm (1.5 in)
Q45XB6CV4Q			100 mm (4 in)
Q45XB6FQ	Glass fiber optic	Infrared, 880 nm	See <a href="#">Optical Performance</a> on p. 4
Q45XB6FPQ	Plastic fiber optic	Visible red, 660 nm	

## Wiring

**Basic sensor**

(no bus card installed - "dumb" sensor)

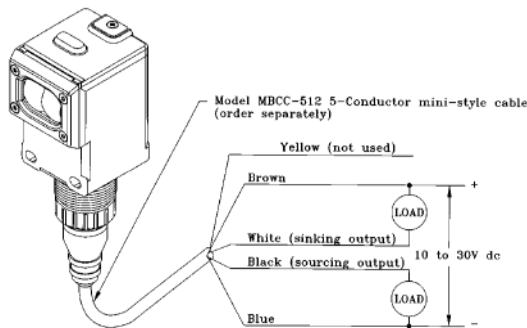

**To bus network**

(bus card installed - "smart" network)

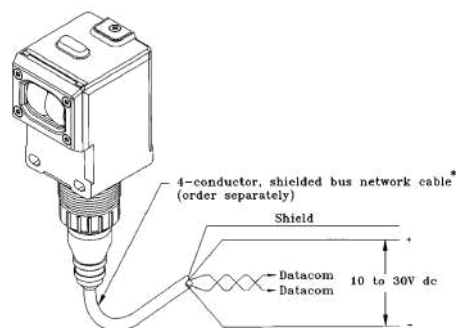

### Notes regarding hookup to bus network

The Q45X offers a 5-pin mini-style quick-disconnect connector, as the standard, so that the proper cable may be selected for the DeviceNet™ bus system. Contact your Banner sales engineer for help in selecting the appropriate cable.

Use of a bus expansion card makes the Q45X a "smart" sensor which can be connected to the DeviceNet™ bus network using a simple "dumb drop" junction box or a "T" connector. Plugging a bus expansion card into a sensor automatically converts the basic outputs to the proper protocol for the DeviceNet™ bus network. Q45X sensors without bus cards (that is, "dumb sensors") may be added to any bus system via a "smart drop" junction box. Of course, basic Q45X sensors interface directly to PLC dc inputs. The block diagram at the right illustrates how "smart" and "dumb" Q45X sensors can be mixed together on the same bus network.

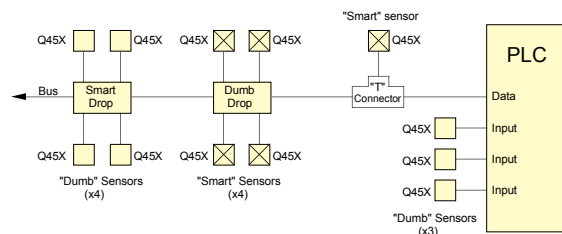

The same model Q45X "smart" and "dumb" sensors may be mixed on the same bus.

## Install or Remove a Q45X Series Module



### CAUTION:

- Shock Hazard
- An electrical shock hazard exists inside the device whenever power is applied. Failure to remove power when the device is open could result in injury.
- Remove all power to the device (and to the load) whenever the device will be opened.



**Note:** It is not necessary to remove power to adjust the Sensitivity or Timing controls, as long as the black inner cover remains in place.

Modules (expansion cards) are installed and removed through the top of the sensor.

1. Remove power from the sensor and load.
2. Loosen the top cover screw.
3. Raise the cover. The cover is hinged at the front.
4. Insert a small screwdriver into one of the slots of the black inner cover, lift up, and remove the black inner cover.



5. If needed, remove a module.
  - a) Insert a small, flat blade screwdriver or similar tool into the lift slot on the edge of the module to be removed.
  - b) Gently pry up to disconnect the card and to raise it until you can grasp it with your fingers.
  - c) Remove the module.



6. If needed, insert a module.
  - a) Insert a module in the expansion slot so that the connector receptacles on the card align with the connector pins inside the sensor.
  - b) Slide the card down into the slot until the connectors are fully engaged.



7. Reinstall the black inner cover.



**Note:** Some expansion cards are supplied with a new (replacement) black inner cover.

8. Close and secure the top cover.
9. Reapply power as desired.

## Functional Schematics

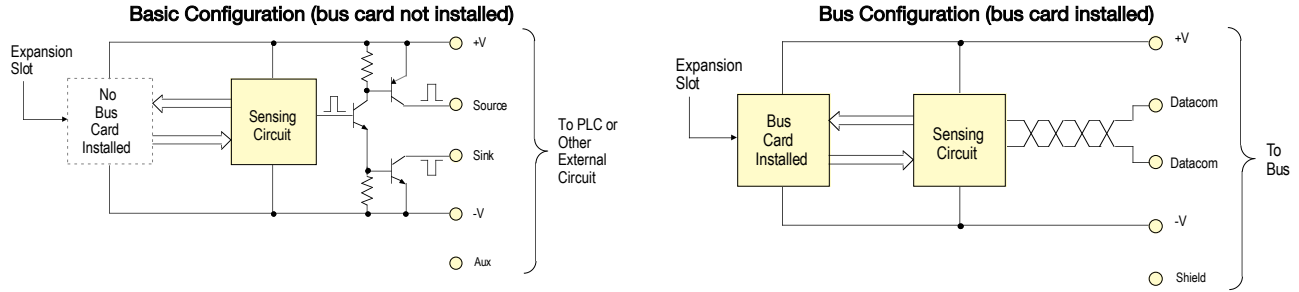

## Specifications

### Supply Voltage

10 V dc to 30 V dc (10% maximum ripple), at less than 50 mA (exclusive of load)

### Output Configuration

**Basic sensor output:** Bipolar; one current sinking (NPN) and one current sourcing (PNP) open-collector transistor

**With optional bus card in expansion slot:** Two-wire datacom interface with protocol corresponding to the Device Net™ bus system

### Output Rating

**For basic sensor configuration, no bus card in use:** 250 mA maximum (each output) up to 50 °C, derated to 150 mA at 70 °C (derate 5 mA/°C)

**OFF-state output leakage:** < 1 µA

**Output saturation voltage (both outputs)** < 1 V at 10 mA and < 2 V at 250 mA. Both outputs are protected against continuous overload or short circuit when the sensor is in the basic configuration

### Circuitry Protection

Protected against reverse polarity and false pulse on power up. Protected against transient voltages

### Response Time and Repeatability

Independent of signal strength. 100 millisecond delay upon power-up (outputs are inactive during this period)

Models Q45X6EQ emitter and Q45XB6RQ receiver: Response = 2 ms on/1 ms off and Repeatability = 0.25 ms

All other models: Response = 2 ms on/off and Repeatability = 0.5 ms

### Adjustments

Multi-turn SENSITIVITY control on top of sensor allows precise sensitivity setting (turn clockwise to increase gain). Internal switch selects Light Operate/Dark Operate. With a network card installed, the sensor must be in Light Operate mode.

### Mounting Options

Standard industrial limit switch mounting via two #10 (5 mm) screw clearance holes on 30 mm centers. Brackets are available for mounting sensor by its 30 mm threaded base (mounting jam nut is included with sensor).

### Status Indicators

Highly visible; located beneath transparent dome on top of the sensor

**Green LED:** Power; lights whenever 10 V dc to 30 V dc power is applied, and flashes to indicate output overload or short circuit

**Red LED:** Signal; Patented Alignment Indicating Device (AID™) System pulses at a rate proportional to the strength of the received light signal. An LED bargraph indicator is available on an optional expansion card for continuous monitoring of signal level and sensing contrast.

**Yellow LED:** Load; outputs conducting

### Construction

Thermoplastic polyester housing, acrylic lenses, stainless steel hardware, o-ring sealed transparent top cover. Designed to withstand 1200 psi washdown (except cable connection).

### Required Cable

Mini-style quick disconnect cable. See [Wiring](#) on p. 1

### Environmental Rating

NEMA 6P, IEC IP67

### Operating Conditions

-40 °C to +70 °C (-40 °F to +158 °F)

### Certifications



## Dimensions

All measurements are listed in millimeters [inches], unless noted otherwise.

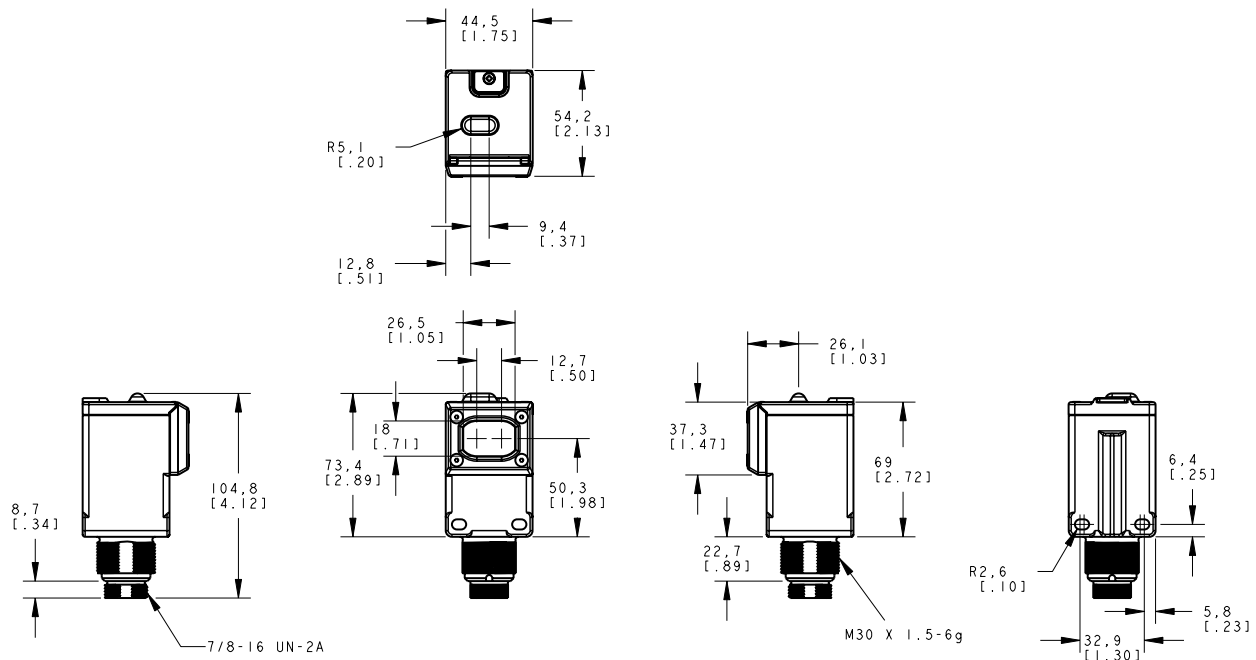



**Note:** 54.6 mm (2.15 in) is the depth dimension for sensors with the following suffixes: E (emitter), D (short-range diffuse), DL (long-range diffuse), LV (retroreflective), and R (receiver).

The sensor depth dimension for other models is as follows:



- CV and CV4 (convergent): 61.5 mm (2.42 in)
- LP (polarized retroreflective): 56.4 mm (2.30 in)
- F (glass fiber optic): 60.5 mm (2.38 in)
- FP (plastic fiber optic): 59.8 mm (2.35 in)

Emitters ("E" model suffix) have the green power status LED only, and no internal adjustments.

A 30 mm jam nut is supplied for mounting the sensor via its threaded base.

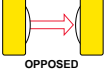
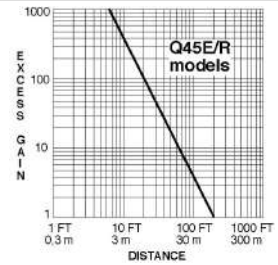
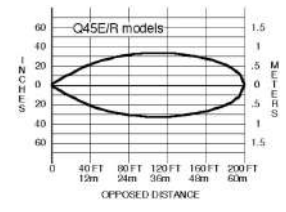
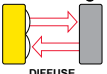
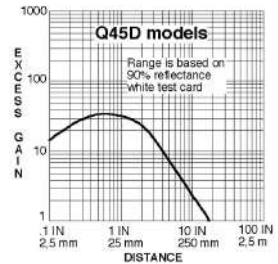
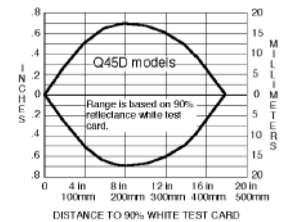
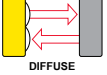
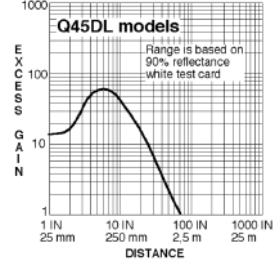
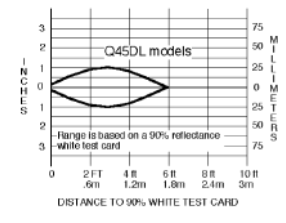
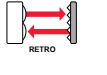
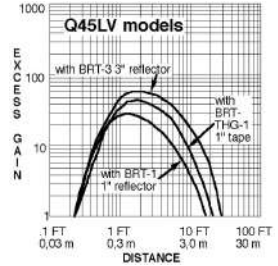
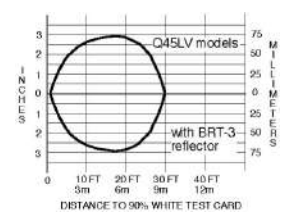
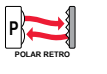
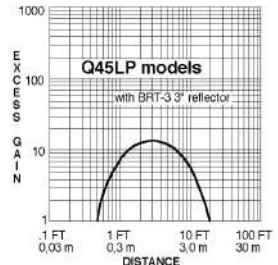
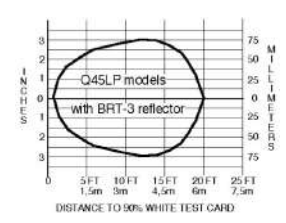
## Optical Performance

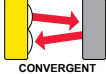
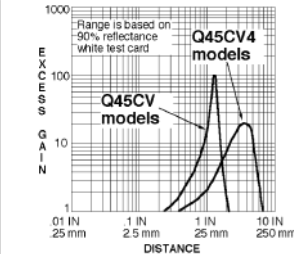
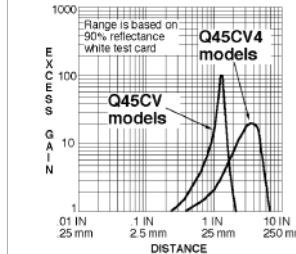
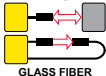
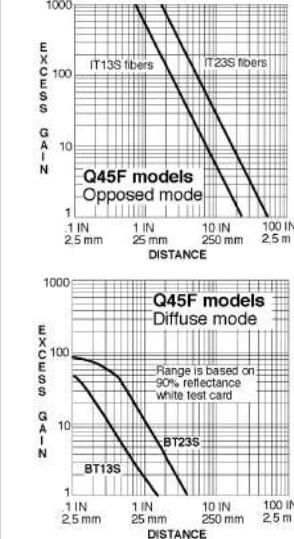
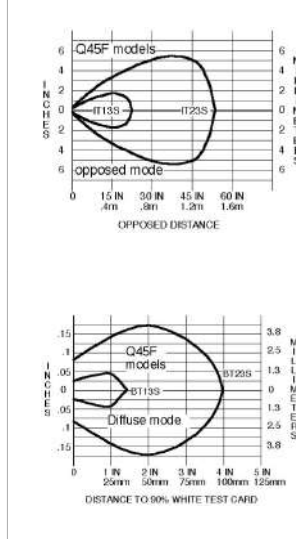
Sensing Mode	Models	Excess Gain	Beam Pattern
<b>Opposed Mode</b>  OPPOSED	<b>Q45X6EQ emitter</b> <b>Q45XB6RQ receiver</b> <b>Range:</b> 60 m (200 ft) <b>Beam:</b> Infrared, 880 nm <b>Response:</b> 2 ms on/1 ms off <b>Repeatability:</b> 0.25 ms		
<b>Short-Range Diffuse (Proximity) Mode</b>  DIFFUSE	<b>Q45XB6DQ</b> <b>Range:</b> 450 mm (18 in) <b>Beam:</b> Infrared, 880 nm <b>Response:</b> 2 ms on/off <b>Repeatability:</b> 0.5 ms		
<b>Long-Range Diffuse (Proximity) Mode</b>  DIFFUSE	<b>Q45XB6DLQ</b> <b>Range:</b> 1.8 m (6 ft) <b>Beam:</b> Infrared, 880 nm <b>Response:</b> 2 ms on/off <b>Repeatability:</b> 0.5 ms		
<b>Retroreflective Mode</b>  RETRO	<b>Q45XB6LVQ</b> <b>Range:</b> 0.08 to 9m (3 in to 30 ft)† <b>Beam:</b> Visible red, 680 nm <b>Response:</b> 2 ms on/off <b>Repeatability:</b> 0.5 ms †with BRT-3 reflector		
<b>Polarized Retro Mode</b>  POLAR RETRO	<b>Q45XB6LPQ</b> <b>Range:</b> 0.15 to 6 m (6 in to 20 ft)† <b>Beam:</b> Visible red, 680 nm <b>Response:</b> 2 ms on/off <b>Repeatability:</b> 0.5 ms		

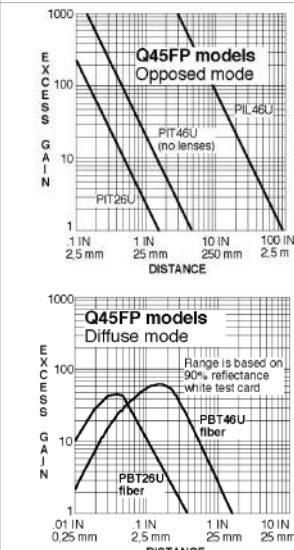
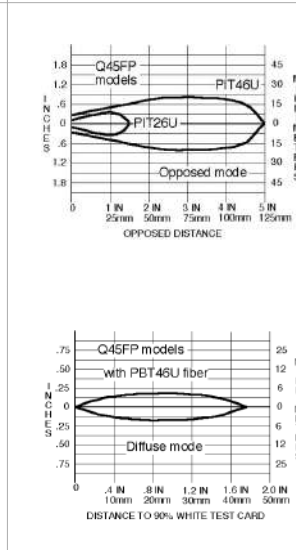
Sensing Mode	Models	Excess Gain	Beam Pattern
<b>Convergent Mode</b>  <p>CONVERGENT</p>	<b>Q45XB6CVQ and Q45XB6CV4Q</b> <b>Ranges:</b> CV focus at 38 mm (1.5 in); 5 mm (0.2 in) diameter sensing spot CV4 focus at 100 mm (4 in); 10 mm (0.4 in) diameter sensing spot <b>Beam:</b> Visible red, 680 nm <b>Response:</b> 2ms on/off <b>Repeatability:</b> 0.5 ms		
<b>Fiber Optic Mode (glass fibers)</b>  <p>GLASS FIBER</p>	<b>Q45XB6FQ</b> <b>Range:</b> see excess gain curves <b>Beam:</b> Infrared, 880 nm <b>Response:</b> 2 ms on/off <b>Repeatability:</b> 0.5 ms		
<b>Fiber Optic Mode (plastic fibers)</b>  <p>PLASTIC FIBER</p>	<b>Q45XB6FPQ</b> <b>Range:</b> see excess gain curves <b>Beam:</b> Visible red, 660 nm <b>Response:</b> 2 ms on/off <b>Repeatability:</b> 0.5 ms		

## Accessories

### 5-Pin Mini Quick-Disconnect Cables

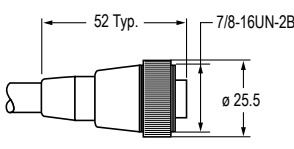
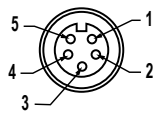

**Note:** For basic sensor hook up only. For bus network hookup, see [Wiring](#) on p. 1.

5-Pin Mini-Style Cordsets—Single Ended				
Model	Length	Style	Dimensions	Pinout (Female)
MBCC-506	1.83 m (6 ft)	Straight		 <p>1 = Black 2 = Blue 3 = Yellow 4 = Brown 5 = White</p>
MBCC-512	3.66 m (12 ft)			
MBCC-530	9.14 m (30 ft)			

## Mounting Brackets

All measurements are listed in millimeters, unless noted otherwise.

### SMB30C

- 30 mm split clamp, black PBT bracket
- Stainless steel mounting hardware included
- Mounting hole for 30 mm sensor

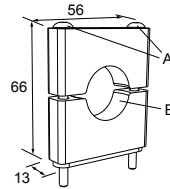

Hole center spacing: A =  $\phi$  45  
Hole size: B =  $\phi$  27.2

### SMB30MM

- 12-ga. stainless steel bracket with curved mounting slots for versatile orientation
- Clearance for M6 (1/4 in) hardware
- Mounting hole for 30 mm sensor

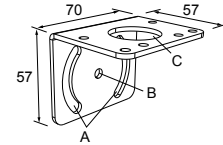

Hole center spacing: A = 51, A to B = 25.4  
Hole size: A = 42.6 x 7, B =  $\phi$  6.4, C =  $\phi$  30.1

### SMB30S

- Swivel bracket with 30 mm mounting hole for sensor
- Adjustable captive swivel ball
- Black reinforced thermoplastic polyester
- Stainless steel mounting and swivel locking hardware included

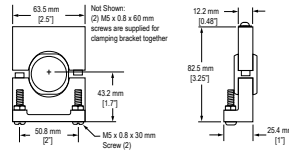

## Banner Engineering Corp. Limited Warranty

Banner Engineering Corp. warrants its products to be free from defects in material and workmanship for one year following the date of shipment. Banner Engineering Corp. will repair or replace, free of charge, any product of its manufacture which, at the time it is returned to the factory, is found to have been defective during the warranty period. This warranty does not cover damage or liability for misuse, abuse, or the improper application or installation of the Banner product.

**THIS LIMITED WARRANTY IS EXCLUSIVE AND IN LIEU OF ALL OTHER WARRANTIES WHETHER EXPRESS OR IMPLIED (INCLUDING, WITHOUT LIMITATION, ANY WARRANTY OF MERCHANTABILITY OR FITNESS FOR A PARTICULAR PURPOSE), AND WHETHER ARISING UNDER COURSE OF PERFORMANCE, COURSE OF DEALING OR TRADE USAGE.**

This Warranty is exclusive and limited to repair or, at the discretion of Banner Engineering Corp., replacement. **IN NO EVENT SHALL BANNER ENGINEERING CORP. BE LIABLE TO BUYER OR ANY OTHER PERSON OR ENTITY FOR ANY EXTRA COSTS, EXPENSES, LOSSES, LOSS OF PROFITS, OR ANY INCIDENTAL, CONSEQUENTIAL OR SPECIAL DAMAGES RESULTING FROM ANY PRODUCT DEFECT OR FROM THE USE OR INABILITY TO USE THE PRODUCT, WHETHER ARISING IN CONTRACT OR WARRANTY, STATUTE, TORT, STRICT LIABILITY, NEGLIGENCE, OR OTHERWISE.**

Banner Engineering Corp. reserves the right to change, modify or improve the design of the product without assuming any obligations or liabilities relating to any product previously manufactured by Banner Engineering Corp. Any misuse, abuse, or improper application or installation of this product or use of the product for personal protection applications when the product is identified as not intended for such purposes will void the product warranty. Any modifications to this product without prior express approval by Banner Engineering Corp will void the product warranties. All specifications published in this document are subject to change; Banner reserves the right to modify product specifications or update documentation at any time. Specifications and product information in English supersede that which is provided in any other language. For the most recent version of any documentation, refer to: [www.bannerengineering.com](http://www.bannerengineering.com).

For patent information, see [www.bannerengineering.com/patents](http://www.bannerengineering.com/patents).